

# Advanced algorithms and tools for LHC Computing

(INTAS-CERN-03-52-4297)

Current status

*A.Kryukov, SINP MSU*  
*([kryukov@theory.sinp.msu.ru](mailto:kryukov@theory.sinp.msu.ru))*



# Outline

- ⇒ Objectives
- ⇒ Project structure
  - Consortium
  - Task list
- ⇒ Brief overview
- ⇒ Conclusions

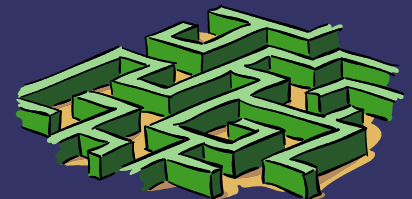

# Objectives

- ⇒ *LHC Computing GRID (LCG)* is the first global GRID infrastructure.
- ⇒ Russian HEP Institutes actively participate in the LCG.
- ⇒ The main goals of this project are
  - Development of advanced algorithms and tools for LCG,
  - Study of optimization problems,
  - Development of data-migration monitoring tools
  - Development methods of testing,
  - Evaluation of middleware for the LCG infrastructure,
  - Deployment of this infrastructure in the Russia.



# *Project structure*

## ⇒ CONSORTIUM

- Information Technology Department CERN, Switzerland
- Institute of Nuclear Physics MSU, Moscow
- Budker Institute of Nuclear Physics, Novosibirsk
- Institute for High Energy Physics, Protvino
- Institute of Theoretical and Experimental Physics, Moscow
- Laboratory of Information Technology JINR, Dubna
- Petersburg Institute of Nuclear Physics
- Forschungszentrum Karlsruhe, HIK – Germany
- Istituto Nazionale di Fisica Nucleare, Padova - Italy

⇒ Duration: 24 Months

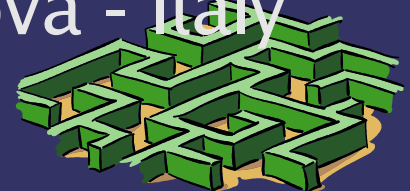

# *Project structure-2*

- ⇒ Specific feature of the project is a multidisciplinary. It is on the cross:
  - Computer science
  - GRID technology
  - MW engineering
  - SW deployment
  - HEP applications
- ⇒ The works are doing with close collaboration with LCG and ARDA in particular.

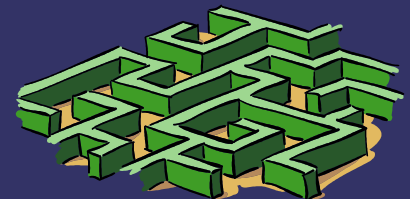

# Project structure-3

## ⇒ Task List

- ✓ Advanced mathematical techniques for LCG ( A. Kryukov, SINP-MSU);
- ✓ GRID monitoring tools (Yu. Ryabov, PNPI);
- ✓ Optimization of data access and transfer in the LCG (V. Korenkov, JINR).
- ✓ The development of test suite for new LCG middle-ware ( I.Bird, CERN-IT, E.Slabospitskaya, IHEP).
- ✓ The use of the Windows platform for LCG tasks (M. Kunze, FZK, V. Korenkov, JINR);
- ✓ Deployment of LCG infrastructure for creating Russian Grid segment (V. Ilyin, SINP-MSU).

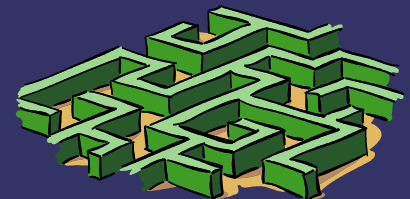

# Advanced algorithms and tools for resource allocation and job scheduling

⇒ EDG/LCG job flow

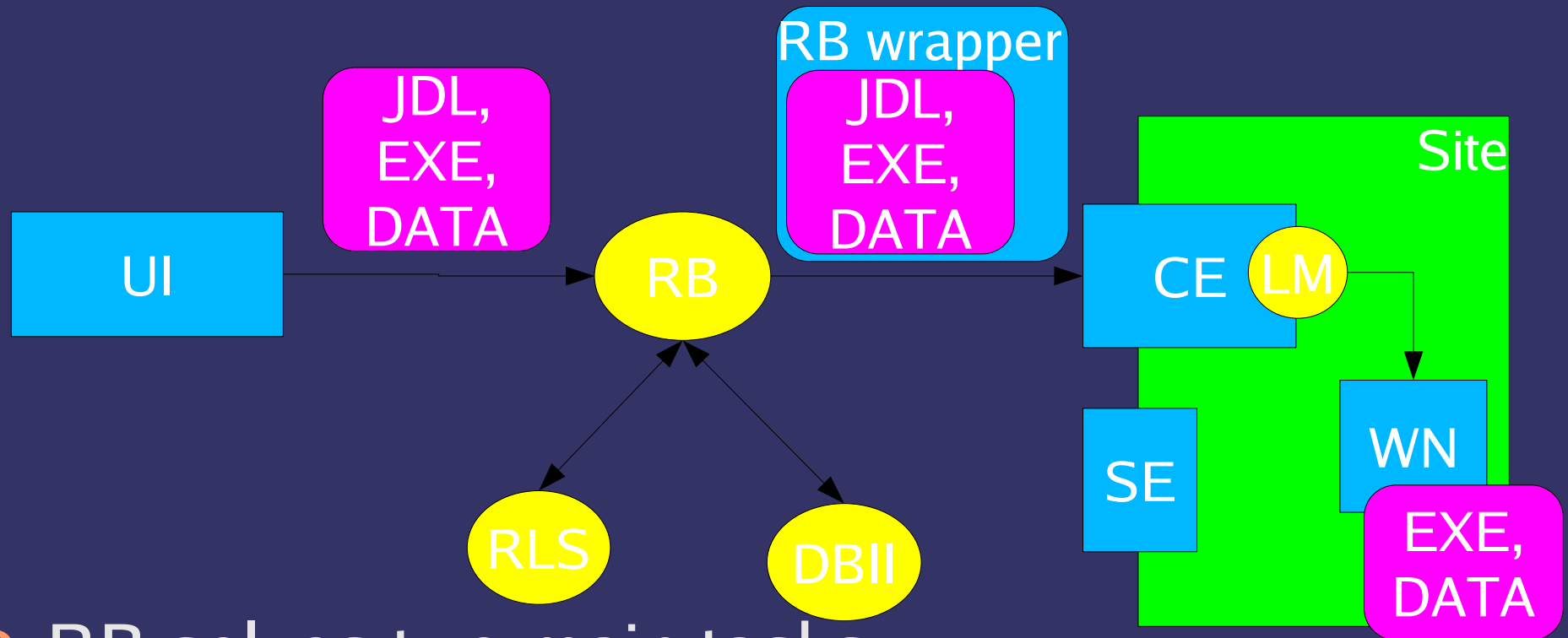

⇒ RB solves two main tasks:

- Find resource matched to job requirements
- Transport files to the CE all files necessary files



# Advanced algorithms and tools for resource allocation and job scheduling

⇒ Improved LCG job flow

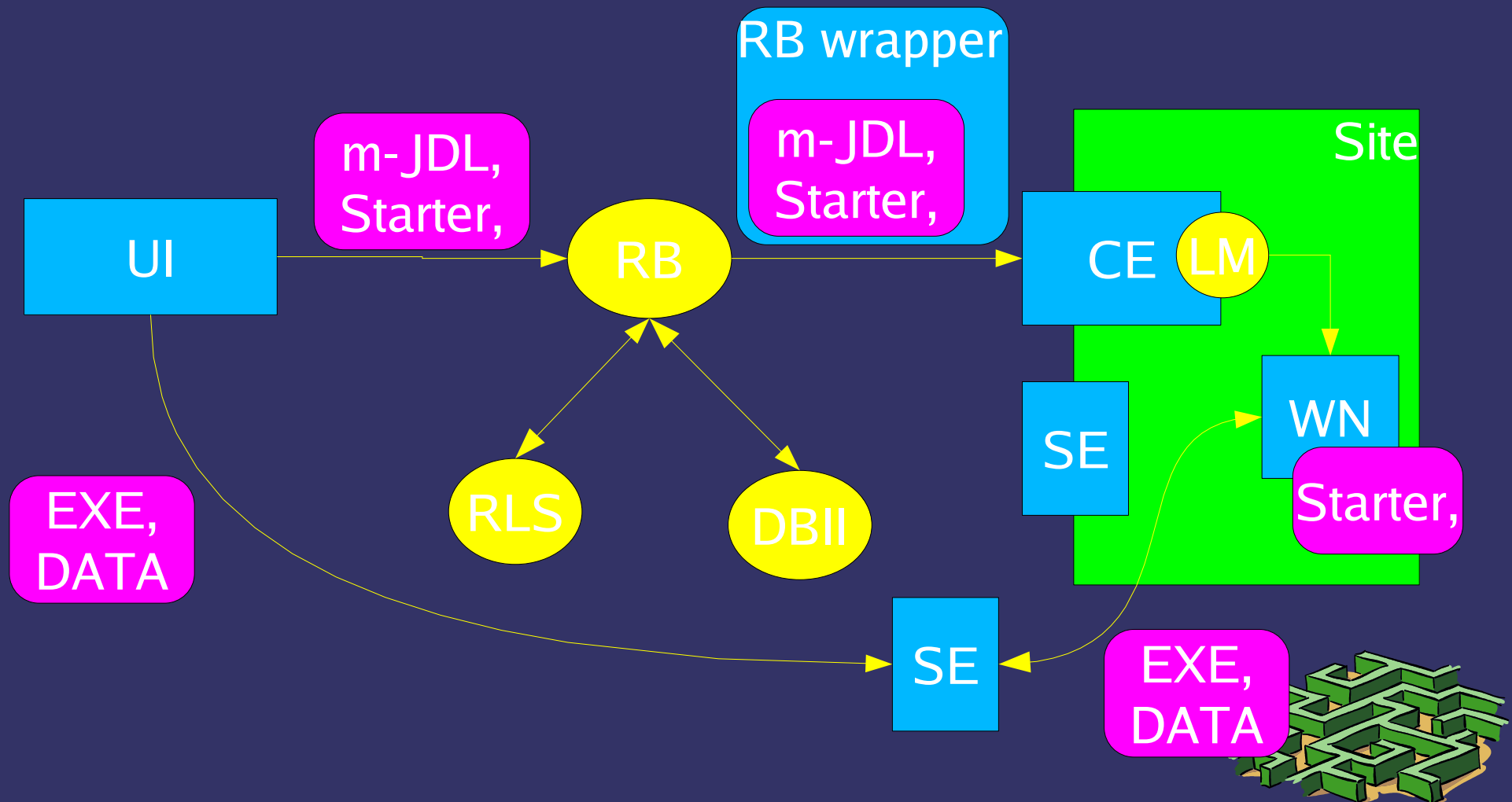



# Advanced mathematical techniques for LCG (cont.)

- Large scale data flow simulation in local and GRID environment

BATCH nodes

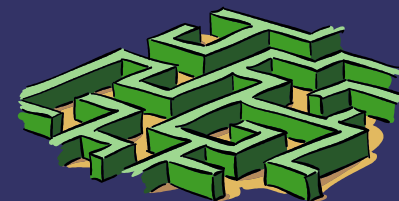
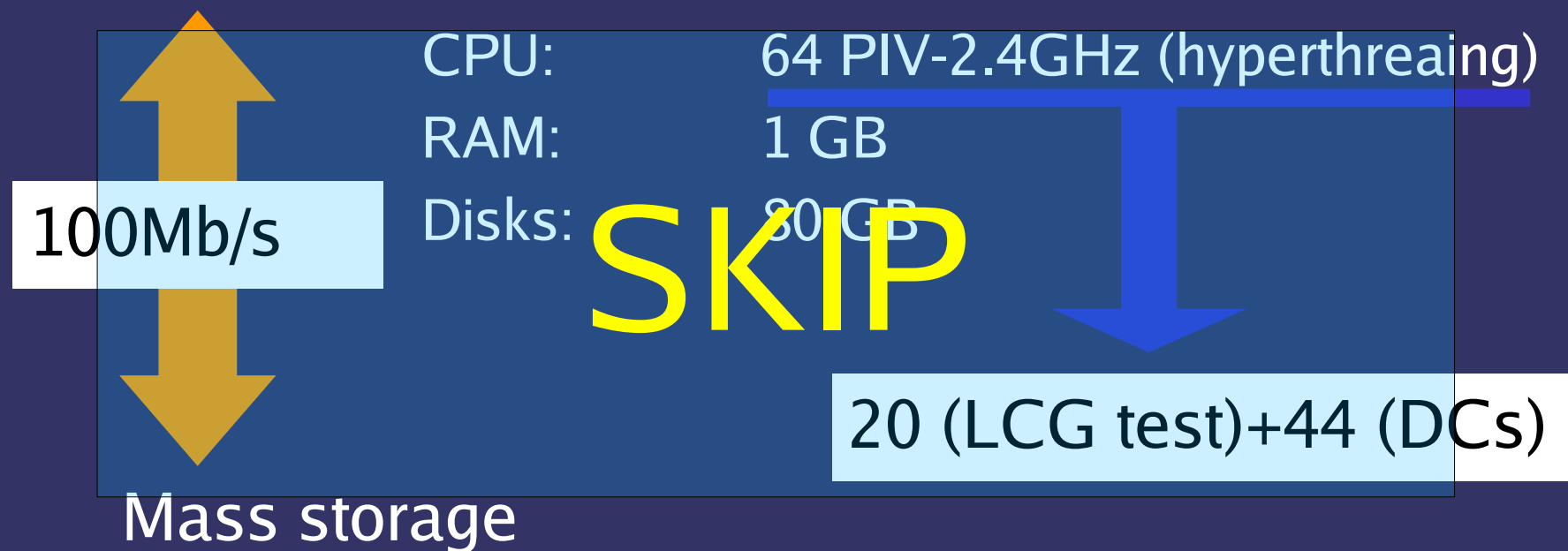

# GRID monitoring tools

- ➔ Monitoring of application jobs: General scheme

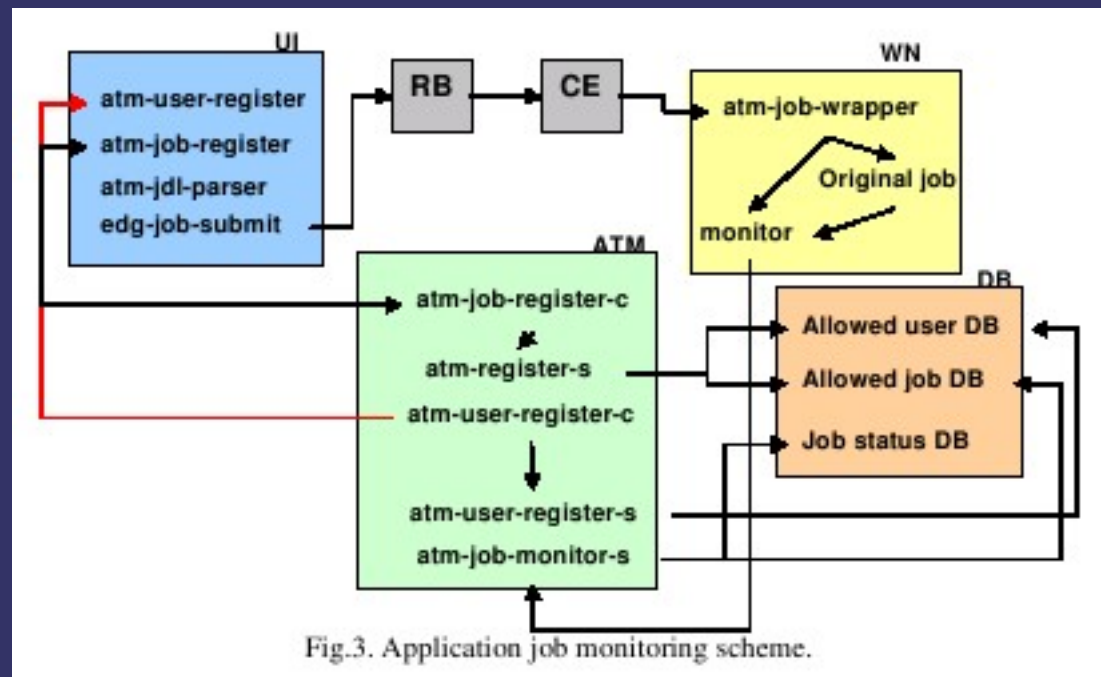
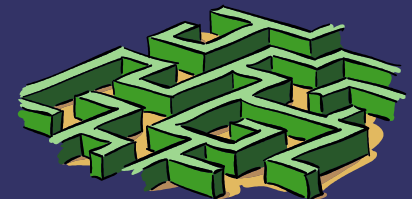

Fig.3. Application job monitoring scheme.



# GRID monitoring tools

➔ Monitoring of application jobs: User Web-interface

Appmon project - Mozilla Firefox

File Edit View Go Bookmarks Tools Help

https://grid.sinp.msu.ru/acgi-bin/tls/appmon.cgi

Support National Geographic O... SMS CERN GRID Daily SINP Яндекс.Lingvo PROMT freshrms.net

Appmon project - Mozilla Firefox

File Edit View Go Bookmarks Tools Help

https://grid.sinp.msu.ru/acgi-bin/tls/appmon.cgi

Support National Geographic O... SMS CERN GRID Daily SINP Яндекс.Lingvo PROMT freshrms.net

Полезная информаци... CIC UK Globus Week - Apr 05 UK Globus Week - Apr 05 Appmon project

**Search results:**

[Reload](#)

- URL: <https://lcg16.sinp.msu.ru:9000/ee794qAK0mAfOy-sHs-uDQ>, current status is: done

Time	Output
2004/12/21-17:00	and pwd: /home/cms001/gram_scratch_SuqJe _CLIPPED_ -mpd/gnu/sbin:/opt/rocks/bin:/opt/rocks/sbin:/opt/edg/bin:/opt/edg/sbin:/opt/edg EDG_WL_LOCATION=/opt/edg LCG_LOCATION=/opt/lcg _=/usr/bin/env
2004/12/21-17:00	Next morning...
2004/12/21-16:58	Firsh morning...
2004/12/21-16:57	One rest minute again.. Trying to get hostname: cmswn114.fnal.gov
2004/12/21-16:56	after 3 minutes: will close soon bye!
2004/12/21-16:55	Running in directory: /home/cms001/gram_ _CLIPPED_ ut -rw-r--r-- 1 cms001 cms 5612 Dec 21 07:54 requestAnalyser.pl sleeping 1.5 minute After 1.5 minutes : Hello world againg. Successfully waked up!

Done grid.sinp.msu.ru

# GRID monitoring tools (cont.)

- ➔ Monitoring of the GRID infrastructure state
  - There are already more than 3000 resources with more than 160 millions statistical records registered in the database.

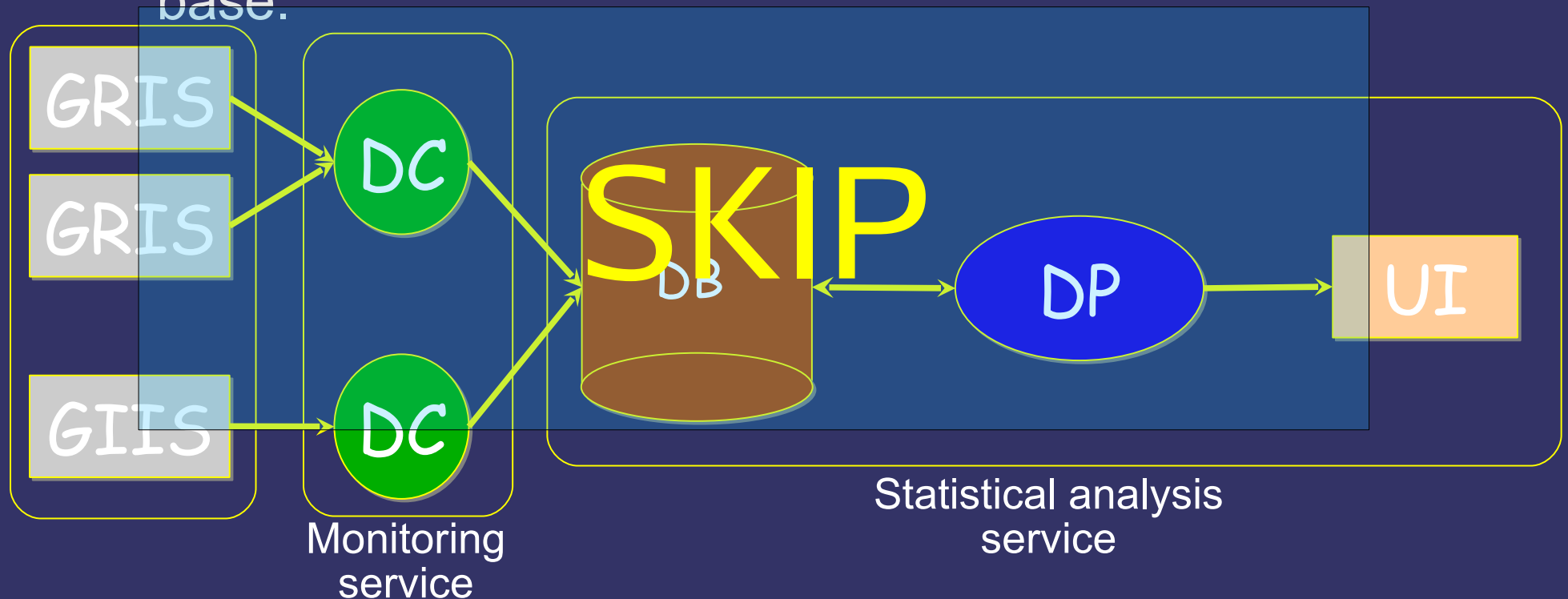

DC – Data Collector, DB – DataBase, DP – Data Processor

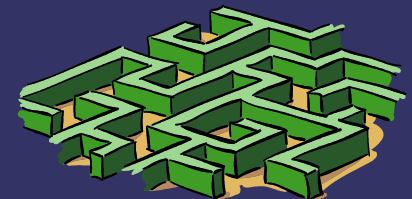

# The development of test suite for new LCG middleware

A logical schema of SRM

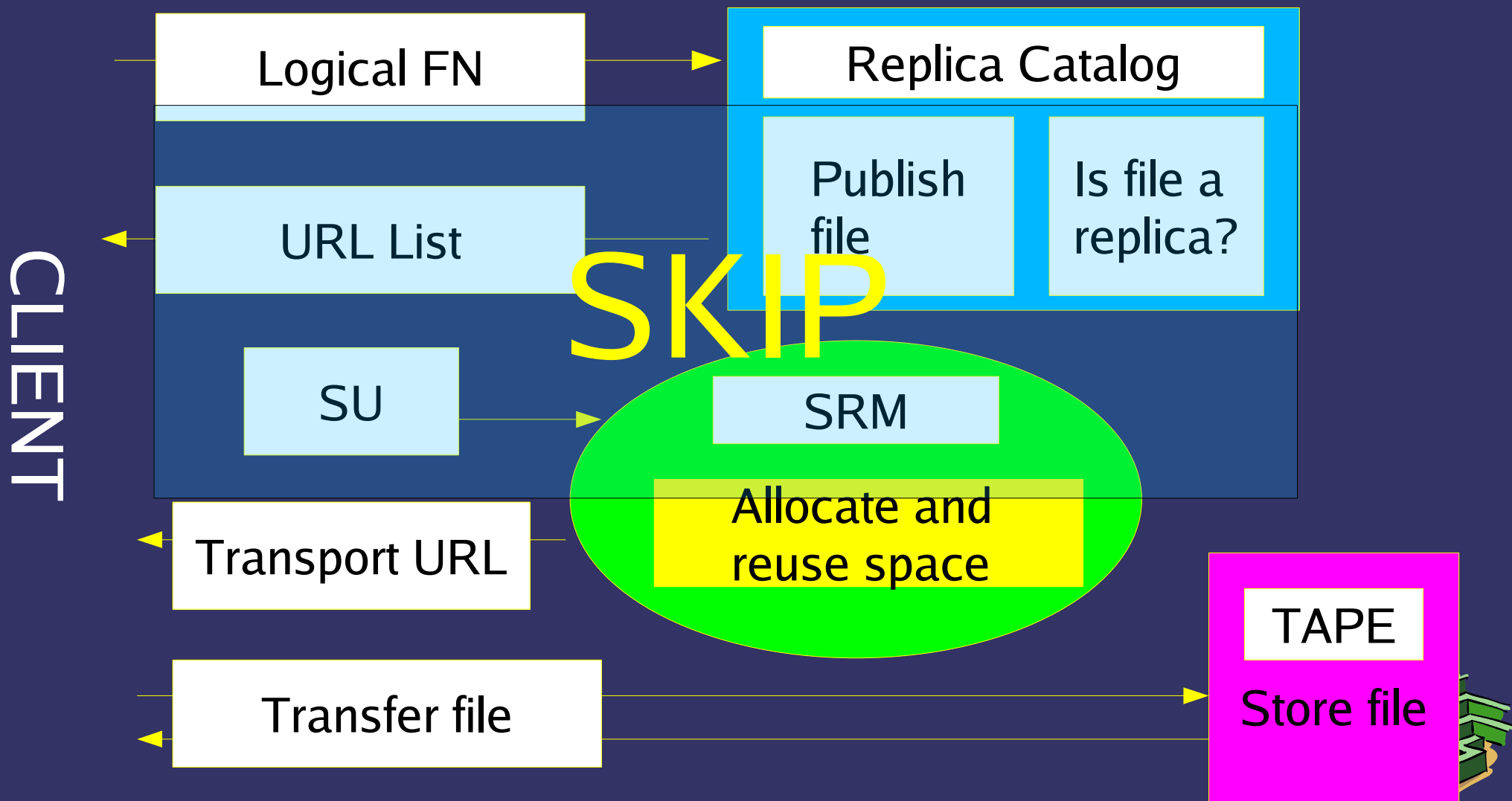

# *The use of the Windows platform for LCG tasks*

- ➔ Use of the VMware for construction of VO's on different platforms and OS versions
  - 50-100 WS w/ Windows2000 + 2 servers in the Cluster “Dubna-Grid” at mean time.
  - SLC305 as the guest OS under VMware WS v.4.5.
  - Ready to connect a few hundreds WN in the Cluster, have temporary administrative issues only.

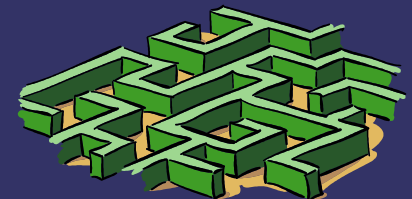



# Deployment of LCG infrastructure for creating Russian Grid segment

→ OGSA/Globus evaluation for data intensive applications

- OMI
- GT4

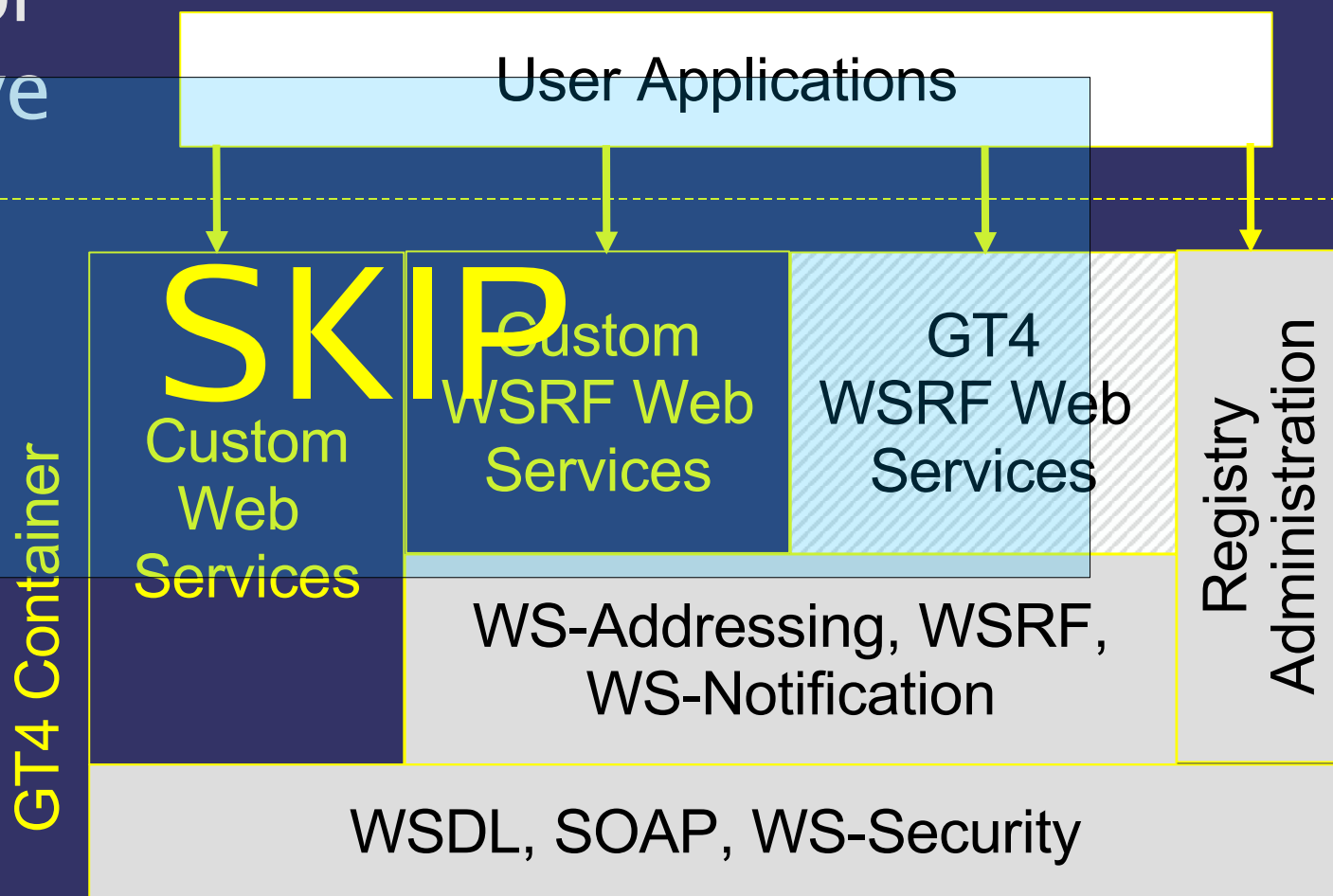



# Deployment of LCG infrastructure for creating Russian Grid segment

- ➔ Development of Russian LCG portal

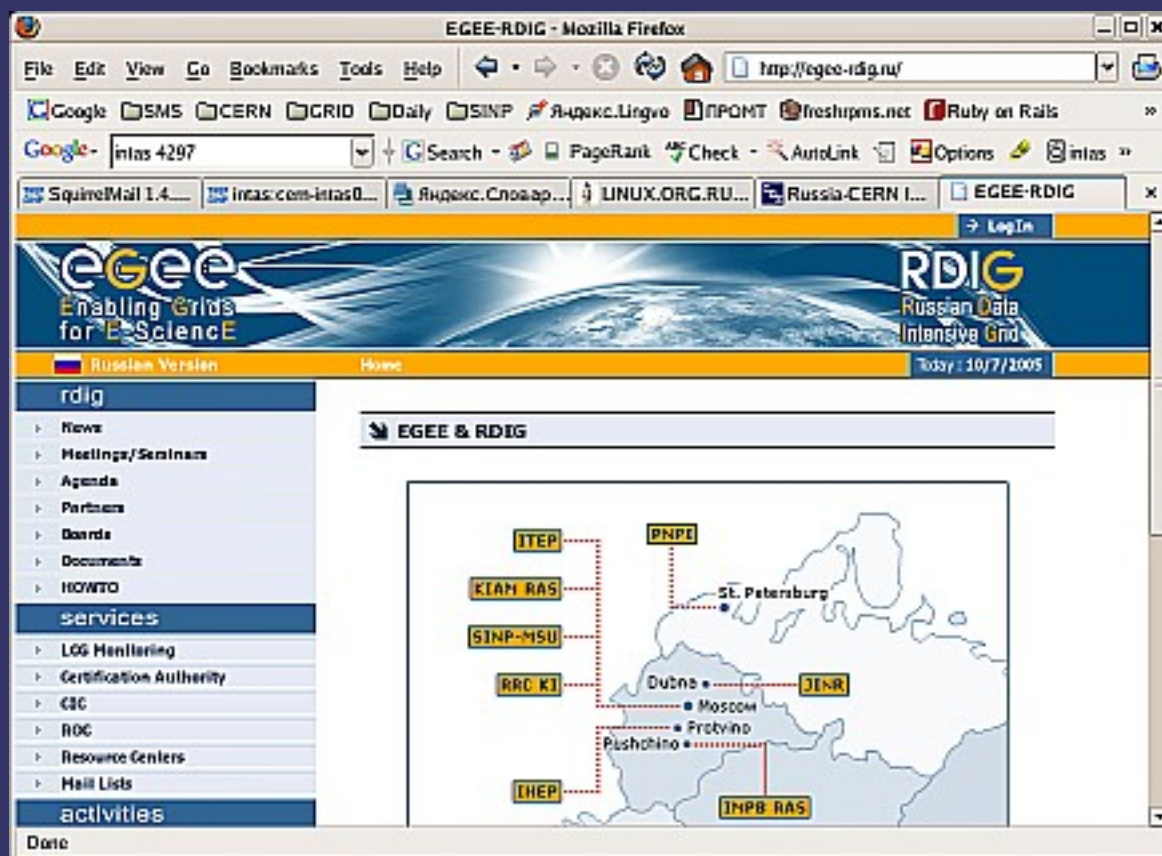

# Milestones

Task	Milestone	Status
Advanced algorithm and tools for resource allocation and job scheduling	March 2005 Dec. 2005	Develop -done Testing – in prog.
Large scale data flow simulation in local and GRID environment	Sept. 2004 Nov. 2005	Develop -done Simulation –in prog.
Monitoring of application jobs	Dec. 2004 Nov. 2005	Develop -done Testing – done



# Milestones-2

Task	Milestone	Status
Monitoring of the GRID infrastructure state	May 2005 Dec. 2005	Develop -done Testing – in prog.
Optimization of data access and transfer in LCG	Dec. 2004 Dec. 2005	Develop -done Data migration tool –in prog.
The development of test suite for new LCG middleware	Dec. 2004 July. 2005	Develop -done gLite – in prog.

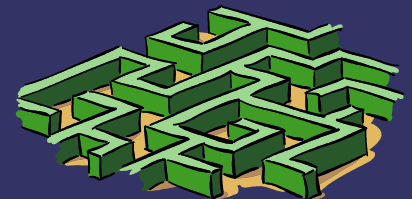

# Milestones-3

Task	Milestone	Status
Use of the VMware for construction of VO's on different platforms and OS versions	Sept. 2004 Oct. 2005	Develop -done Analysis – in prog.
Porting some of the LCG software on the MS Windows .NET platform	Sept. 2004 Sept. 2005	Develop -done Operation –in prog.
Installing and testing components of the LCG infrastructure to achieve full-scale functionality	March 2005 Dec. 2005	Deployment -done Operation – in prog.

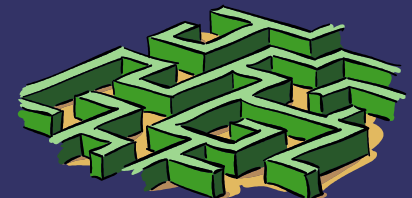

# Milestones-4

Task	Milestone	Status
OGSA/Globus evaluation for data intensive applications	June. 2004 March 2005	GT3 -done GT4 – postponed (appear 29, April)
Development of Russian LCG portal	Oct. 2004	Develop -done

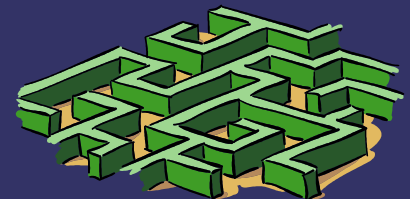

# Web support of the project

⇒ Web site:

<http://theory.sinp.msu.ru/dokuwiki/doku.php?id=intas:cern-intas03:main>

⇒ Collaborative tools

- Wiki
- Mailing list

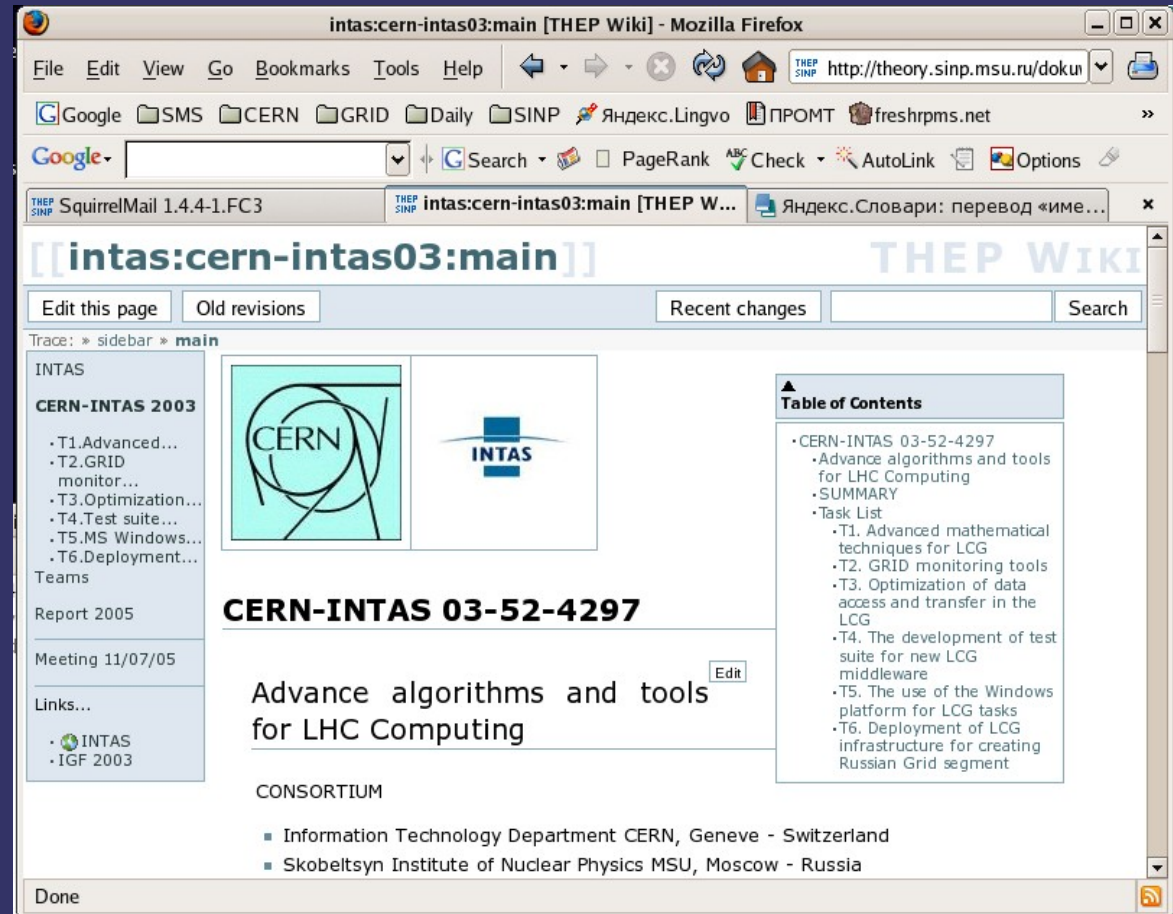

# Conclusions

- ⇒ Most teams have a good progress.
- ⇒ There were obtained very important results which can be applied for improvement of LCG infrastructure, in particular:
  - Decreasing job submission failure rate
  - Improvement of monitoring facilities of jobs
- ⇒ Get real experience of expanding grid on M\$ Windows computers via WMWare.
- ⇒ And much more...
- ⇒ **CERN-INTAS grant provides a good financial basis for the scientific research**

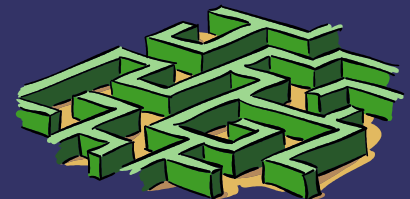

# References

## Incomplete list

- A.Demichev, V.Ilyin, A.Kryukov, L.Shamardin, Integration of GRID segments with different architectures (in Russian), in Proceedings of All-Russia conference “e-Libraries: Advance methods and technology”, 29 of September – 1 of October, 2004.  
[http://www.impb.ru/~rcdl2004/cgi/get\\_paper\\_pdf.cgi?pid=22](http://www.impb.ru/~rcdl2004/cgi/get_paper_pdf.cgi?pid=22)
- D. Chen, A. Demichev, D. Foster, V. Kalyaev, A. Kryukov, M. Lamanna, V. Pose, R. Rocha and C. Wang, OGSA Globus Toolkit3 evaluation activity at CERN • Nuclear Instruments and Methods in Physics Research, A534(2004), pp 80-84
- Bitutsky A.B., Kiryanov A.K., Ryabov Yu.F., Using Grid Infrastructure State Monitoring to Enhance Resource Selection, report on the Int. Conf. “Distributive calculation and GRID Technology in Science and Education”, Dubna, 29 of June – 2 of July, 2004.
- Ilyin V., Korenkov V., Participation of Russian Institutes and JINR in LCG and EGEE projects, report on the Int. Conf. “Distributive calculation and GRID Technology in Science and Education”, Dubna, 29 of June – 2 of July, 2004.
- Baud J-Ph., Bird I., Sekera Z., Lazin Yu., Motyakov V., Petoukhov V., Slabospitskaya E., SRM Testing for LCG-2, report on the Int. Conf. “Distributive calculation and GRID Technology in Science and Education”, Dubna, 29 of June – 2 of July, 2004.

An so on ...

